

VIDEOTRONIC **V585.2 PREMIUM**

V585.2

WHEEL BALANCERS

The perfect combination.

WINDOWS CE



**SONAR
OPTION**



**LASER
OPTION**



**PNEU-LOCK
OPTION**

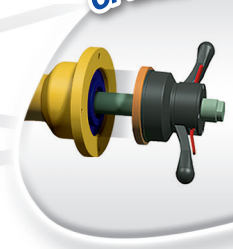

V585

V585.2.PL.ULX

Cod. V103.005 - Edizione n. 1 - Gennaio 2019



FASEP 
MADE IN ITALY

SOMEONE YOU CAN TRUST

1969 • 2019

Technologically unsurpassed and still easy to use.

EMS

Automatic width gauge.

OPTION

LCD SVGA 19" monitor.
8 buttons key pad with icons.

Compartments for weights (7),
cones (4+6) and tools (1).

ALU-SE

Automatic input/gauge
to measure and apply stick-on
weights.

Flange holder side cab **OPTION**

PC Control Unit
with USB port.



FASEP WHEEL BALANCING SYSTEM

TriSensor

3 sensors system
for unbalancing measurement.

IFS

Integrated-flange shaft for
maximum centering accuracy.

LASER

Laser pointer to ease
application of adhesive
weights.

The Laser System
makes it **easier**
and **accurate**
the application
of adhesive
weights inside
the rim.

LASER



LED-LIGHT



Wheel NOT lighted

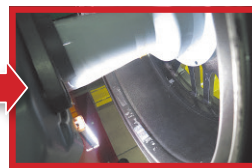

Wheel lighted with LED-LIGHT

Safety cover with
automatic start-stop
when closed. It reduces
space requirements.

EMS

ALU-SE TriSensor
+IFS

V585

PNEU-LOCK

LED LIGHT
& LASER

OPTION

Lower wheel guard

PNEU-LOCK

Double effect pneumatic lock.



PNEU-LOCK

- **YES** Effortless accurate clamping.
- **YES** Safe operation
- **YES** It operates even in the event of malfunction of pneumatic or lack of compressed air.

Designed for the tyre specialists, V585.2 is the perfect combination between price and performances. V585.2 incorporates the latest low-speed technology with 16-bit electronics. Also, the software, stored on a Flash memory, can be upgraded in seconds. The Heavy Duty shaft allows

90 kg of maximum weight on the shaft, a record unsurpassed. The heart of the balancer is built around the TriSensor System, a FASEP exclusive design, and IFS System (integrated-flange shaft) for maximum centering accuracy. Customized special version.

The advantages of FASEP Balancing System



FASEP Wheel Balancing System TriSensor + IFS: simply incomparable!

3 Sensors System

for unbalancing measurement

TRISENSOR

Ideal system

- **NO** no need of mechanical ties
- **YES** it is stable by itself
- **YES** the centrifugal force goes completely through the sensors
- **YES** the unbalance is completely measured
- **YES** with each type of wheel, also of large size or width, results are always perfect

Exclusive FASEP Design!

TRISENSOR

Fasep mechanics, view from top and exploded, with the 3 sensors clearly visible.

INTEGRATED FLANGE Shaft (IFS)

for a perfect centering

IFS INTEGRATED FLANGE SHAFT

- **YES** the bell flange is integrated in the shaft
- **NO** it doesn't need to be mounted
- **NO** dirt or usury
- **YES** tolerances of coupling are eliminated
- **YES** it improves dramatically the centering accuracy

- 1 The bell flange is integrated in the shaft. **It doesn't need to be mounted.** No tolerance of coupling.
- 2 The rear spring for the use of the inner cone is **integrated in the shaft.** It is not necessary to mount it and it is protected against dirt, **facilitating the operator** in mounting the wheel.
- 3 Inner cone. **Centering** is absolutely **easy and accurate.**



RESULTS ALWAYS PERFECT!

No coupling shaft-bell: accuracy of centering!



G3.EXTREME

The new **G3.EXTREME** technology includes a series of improvements all contributing to the **reduction of working time.**

G3.EXTREME news:

- Electronic motor control (inverter)
- Use of quiet and powerful three-phase motors
- Very quick cycle time (start, braking and automatic wheel positioning in 5.5 sec)
- Automatic positioning system APS2 faster and more accurate, controlled by the keyboard or the brake pedal
- Electromagnetic brake included as standard
- 50-60Hz seamless operation (electronic motor control operates shaft always at same speed)

APS 2
Quick and accurate positioning of the wheel.

AUTOSELECT 2

AUTOSELECT 2
Autoselect function improved and enhanced.

SONAR

OPTION

External automatic measuring system



STANDARD EQUIPMENT

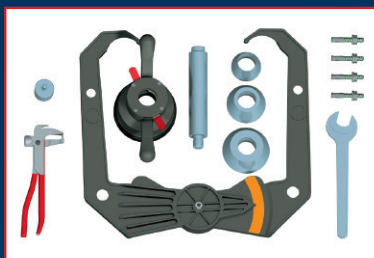

OPTIONAL EQUIPMENT



FUL-HD
Universal
Self-centering
flange

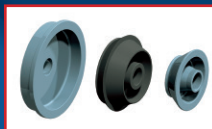

KF
Kit Off-road
& Light Trucks

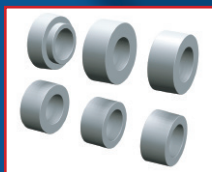

SBC
Set centering
bushings



FC
Centering
flanges
4/5 holes

TECHNICAL FEATURES

• Power source	220V 50-60Hz 1Ph
• Motor power	50 W
• Power source	400 W
• Balancing speed	98 RPM
• Rim diameter	8" (200 mm) - 26" (650 mm)
• Rim diameter (alu-s)	8" - 23"
• Wheel Diameter (max) with wheel-guard	34" (850 mm)
• Rim Width (max) with wheel-guard	16" (415 mm)
• Wheel Weight (max)	90 Kg (198 Lbs)
• Measuring time	8 - 15 s.
• Accuracy	1 gr.
• Angular accuracy	256 divisions (accuracy = 1,4 deg)
• Monitor	LCD SVGA 17"
• Noise	< 70 dB (A)

FUNCTIONS

- Unit of measure
- **START-STOP** Automatic
- Display step 1 or 5 gr
- Display cut-off 1 to 9 gr
- **STOP-ON-TOP** at the end of measuring run (only 1Ph)
- Autodiagnostic
- Autocalibration
- **SPLIT** Possibility to divide the balance weight and hide behind the spokes in a non-visible position
- Statistics
- **FCC** Fast Calibration Check
- Rim Databank
- **ALU-S** ALU Special function
- **ALU-SE** Electronic ALU-S function
- Information center (telediagnostic)
- **MARS** Automatic Minimization of Residual Static Unbalance
- Optimization (LEVEL 2)
- Rim run-out: check rim geometry/eccentricity
- Planarity
- **AFC** Automatic Flange Calibration
- **ASF** ALU Special functions (LEVEL 3)
- **APS** Automatic Positioning System (LEVEL3)
- **FAST** Fast balancing mode (LEVEL3)



- A= 300 mm
- B= 1160 mm
- C= 1160 mm
- D= 1790 mm
- E= 1470 mm
- E1=1170 mm
- F= 1280 mm

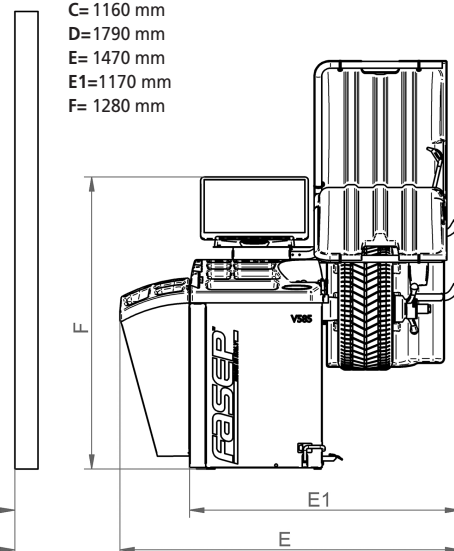
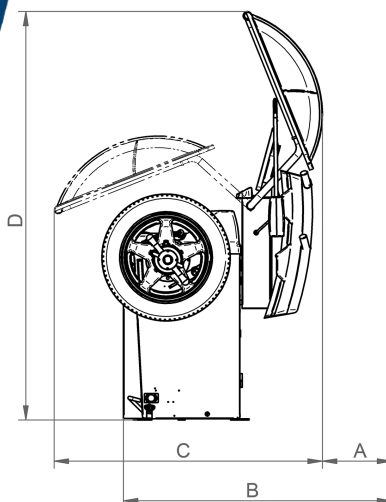

FURTHER ACCESSORIES ON

www.fasep.it

Authorized dealer



For further information
about this and other
products, please visit
www.fasep.it



FASEP 2000 s.r.l.
Via Faentina, 96 - 50032 Ronta (Firenze) ITALY
Tel. +39 055 8403126 - Fax +39 055 2691906